

## USER MANUAL

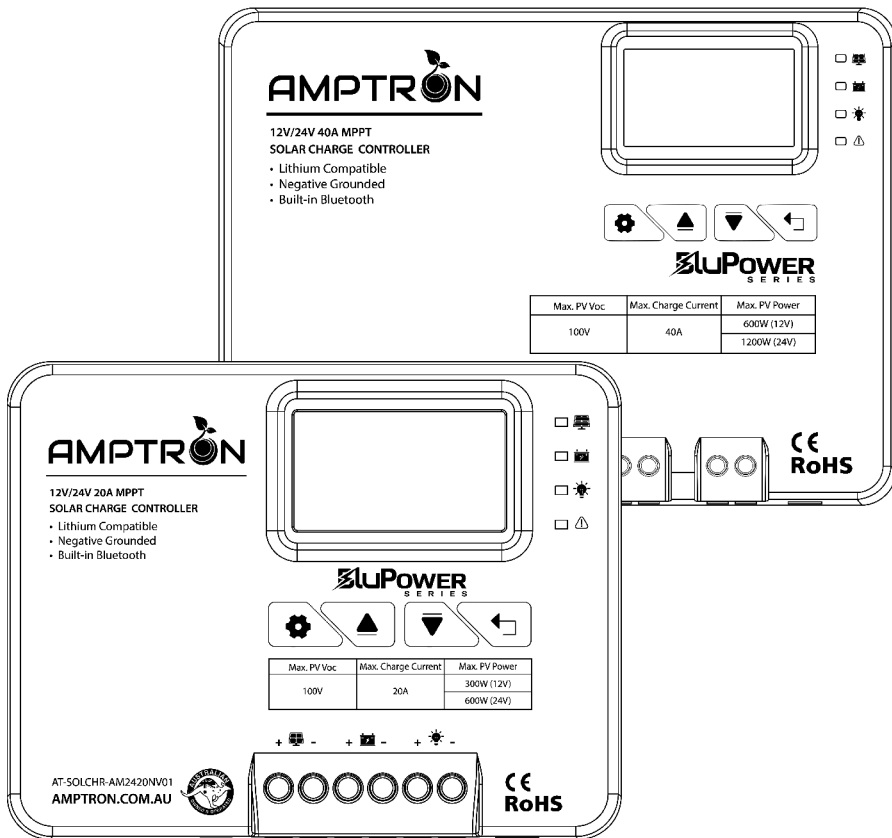







### MPPT CHARGE CONTROLLER

Negative Grounded  
**AM2420N / AM2430N AM2440N / AM4860N**

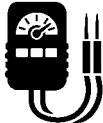

*\*We may modify these specifications without prior notice.*

## Warnings and Tools Icon Chart

Icons	Name	Description
	High Voltage	High voltage device. Installation should be performed by an electrician.
	High Temperature	This device will produce heat. Mount device away from other items.
	Environmental Hazard	Electronic Equipment. Do not put in landfill.
	Wire Cutter	A wire cutter is needed for cutting and stripping wires prior to connection.
	Multimeter	A multimeter is needed for testing equipment and verifying polarity of cables.
	Anti-static Glove	Anti-static gloves are recommended to prevent controller damage caused by static electricity.
	Electrical Tape	Electrical tape is recommended to safely insulate spliced or bare wires.
	Screwdriver	A common size screwdriver is needed to attach wires to the controller.

## Safety Tips

- Review this manual thoroughly before attempting installation.
- Beware of any nearby electrical equipment that may interfere with installing this device.
- Solar panels can generate high voltages and currents, make sure your solar panels are completely covered from sunlight during installation. It is recommended that installation be performed by a qualified electrician.
- Connecting wires to this device can generate sparks, please wear proper insulation gear while installing this device.
- To avoid damage to the battery or controller, use proper fuses in wiring. Please contact a professional if you need help with fuse sizing.
- Always keep children away from this device.
- Use the correct gauge wires, refer to the below table for recommended wire sizes for various current loads.

Solar Input Current	5A	10A	20A	30A	40A	60A
Wire Cross Section Area (mm <sup>2</sup> )	1.5	2.5	5	8	10	12
Wire AWG	15	13	10	8	7	6

## Product Features

This MPPT solar charge controller is a device for solar charge regulation and direct current output load control.

These MPPT charge controllers have features as follows:

- By continuously checking solar panel power output changes, the controllers employ multiple MPPT charge algorithms in combination to boost charging efficiency in different weather and temperature conditions.
- Built-in buffer allows the rated power input to be exceeded by a maximum of 25%.
- Charging modes available for most common deep-cycle battery types, including AGM, Sealed, Flooded and GEL lead acid, and Lithium.
- Auto recognition of 12V/24V battery system voltage by AM2420N/AM2430N/AM2440N model; auto recognition of 12V/24V/36V/48V battery system voltage by AM4860N model. Lithium battery excluded from this feature.
- Supports recording of system running data including power generated and power utilized for up to 300 days, compatible with monitoring App through IOS and Android.
- Allows mobile phone APP operation for monitoring and parameters settings via built-in Bluetooth communication module. An APP PVChargePro is provided for mobile phone monitoring and operation. You can search for “PVChargePro” and download the APP at the IOS APP Store and Google Play Store.
- Provides multiple load control mode options for light based, time based and manually adjusted scenarios. Low no-load loss.
- Industrial grade design with reverse polarity protection for solar panels, battery, and load.

## Device Diagram

AM2420N&AM2430N&AM2440N & AM4860N

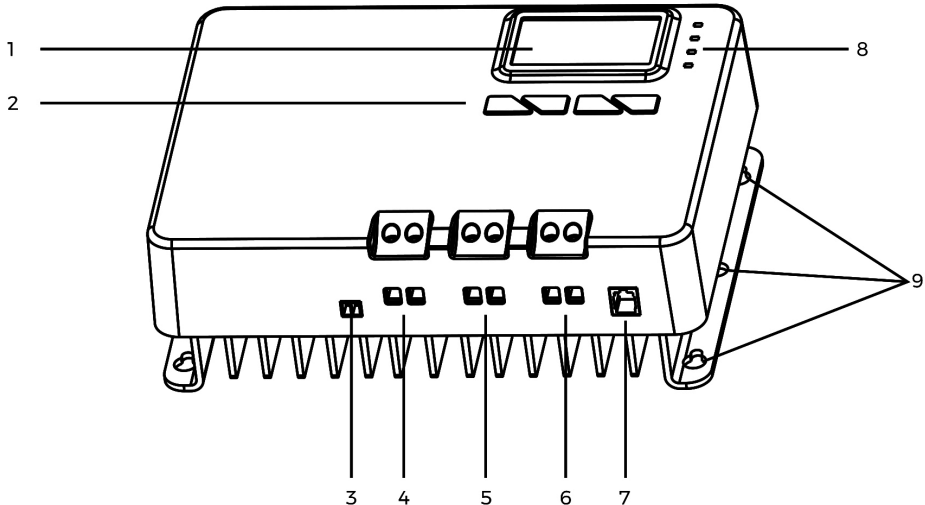

#	Description	#	Description
1	LCD Display Screen	6	DC Load Terminals
2	Function Keys ([SETTING], [UP], [DOWN], [ESC])	7	RS485 Communication Port
3	External Temperature Sensor Terminal	8	LED Indicator (PV, BAT, LOAD, FAULT)
4	Solar Terminals	9	Installation Mounting Holes
5	Battery Terminals		

## Mounting Instructions

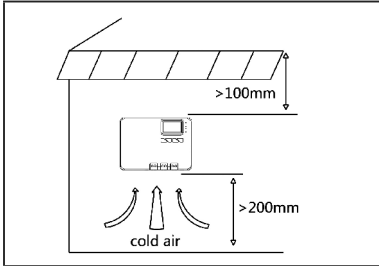

### Step 1:

Find a cool, dry and weather safe location for installation.

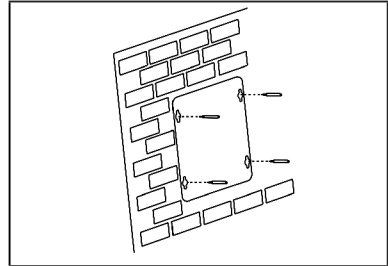

### Step 2:

Mark the controller's mounting holes on the mounting surface.

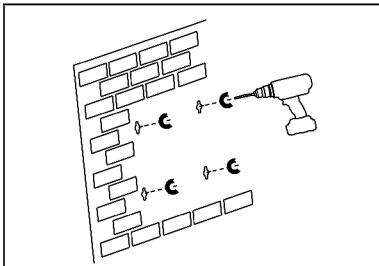

### Step 3:

Drill holes in the marked mounting hole locations.

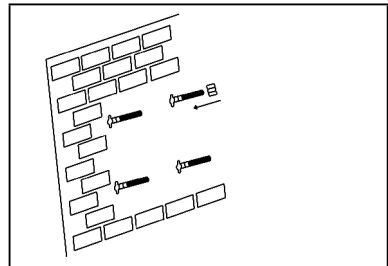

### Step 4:

Insert pilot screws in the mounting holes.

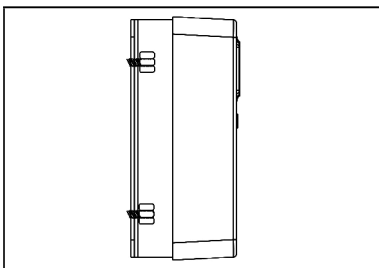

### Step 5:

Mount the controller into the pilot screws and fasten the screws.

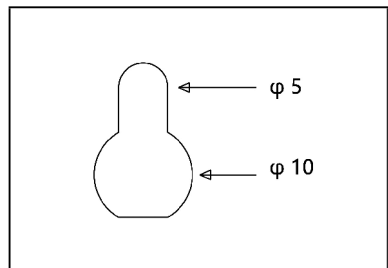

### Step 6:

Continue to wire the battery, solar DC load and other accessories to the controller.

## Wire Connection Sequences

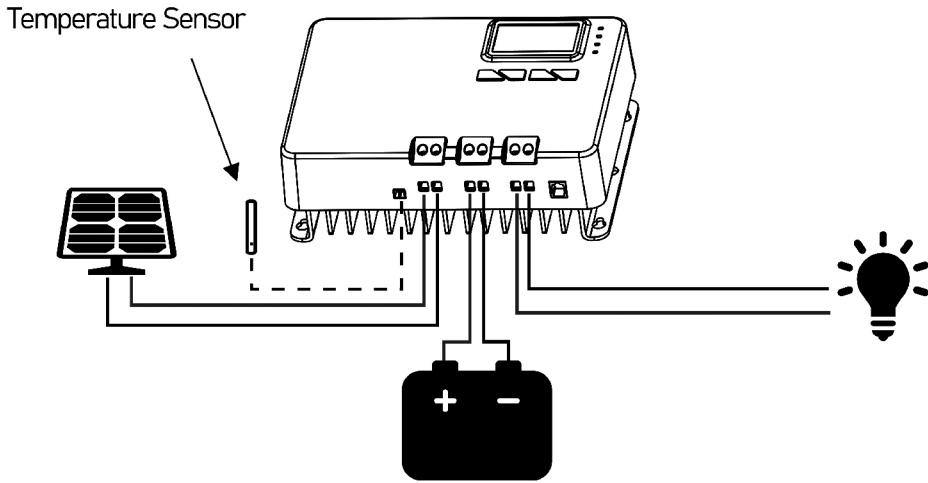

During installation of your MPPT controller, please follow the order of connections below:

- Connect the positive battery wire followed by the negative battery wire.
- Make sure your solar panels are fully covered to prevent electrical shock.
- Connect the positive solar array output wire followed by the negative solar array output wire.
- Connect DC load wires to the DC load output (if applicable).
- Connect the external temperature sensor to its terminal shown above.
- Download APP PVChargePro and turn on the Bluetooth function in your mobile phone to connect the APP with the controller.





## LED Light Signal Interpretation Chart

LED Name	LED Display	Signal Indication
PV	Off	Solar Input Not Charging *PV LED is generally off during night time
	Double Flash	Solar Input Charge Detected
	Single Flash	Solar Input Reverse Polarity
	Steady On	MPPT Charge Mode
	Fast Flash	Equalize or Boost Charge Mode
	Slow Flash	Float Mode
BATTERY	Single Flash	Battery Input Reverse Polarity
	Fast Flash	Battery Over Voltage
	Slow Flash	Battery Over Discharged
	Steady On	Battery On
LOAD	Off	No DC Load Connected/ Load Off
	Fast Flash	DC Load Short Circuit
	Steady On	DC Load On
FAULT	Off	No Errors
	Steady On	System Error – Check Error Code

Check the fault light to spot if a system error may be present.

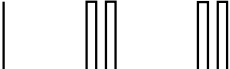

## LED Flash Rhythm Chart

Flash Status	Indication	Description
Steady On	on  off	LED light on
Off	on  off	LED light off
Fast Flash	on  off	LED light blinks at frequency of 2Hz (twice every second)
Slow Flash	on  off	LED light blinks at frequency of 0.5Hz (once every two seconds)
Single Flash	on  off	LED light blinks for 0.1 second after every 2 seconds
Double Flash	on  off	LED light blinks for 0.1 second twice after every 4 seconds



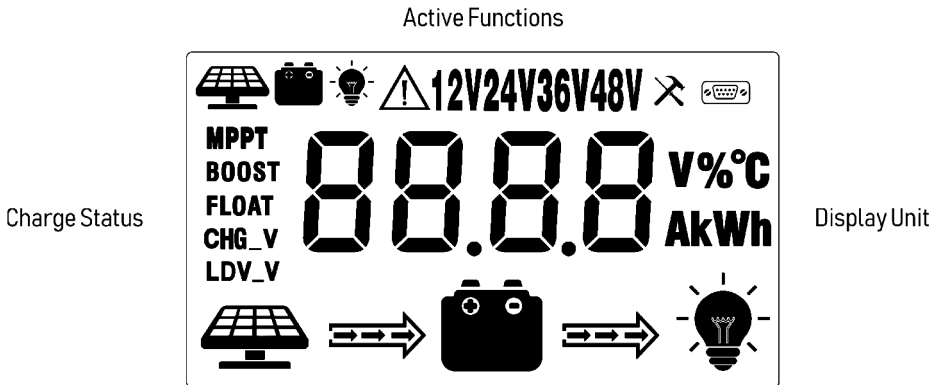

## LCD Display Interface Overview







## LCD Display Interface





Display Section	Display Layout
Charge Status	→  →
Charge Mode & Parameter	<p>MPPT BOOST FLOAT CHG_V LDV_V</p> <p><b>88.88</b> V%°C AkWh</p>
Active Functions	<b>12V24V36V48V</b>

## Status Information

Status Icon	Indication	Status	Description
	Solar Charge Indication	Flowing	Solar Power Charging Battery
		Off	Solar Power Not Charging Battery
	DC Load Indication	Flowing	DC Load Drawing Power
		Off	DC Load Off
<b>MPPT</b>	Charge Mode	Steady On	MPPT Charge Mode
<b>BOOST</b>			Boost Charge Mode
<b>FLOAT</b>			Float Charge Mode
		Off	Not Charging
<b>CHG_V</b>	Voltage Setting	On	Setting Charge Voltage
		Off	Charge Voltage Has Been Set
<b>LDV_V</b>	Over Discharge Volt Settings	On	Setting Discharge Voltage
		Off	Discharge Voltage Has Been Set
	Solar Icon	Steady On	Daylight Detected
		Off	No Daylight Detected
		Fast Flash	Solar System Over Voltage
	Battery Icon	Steady On	Battery Connected and Functional
		Off	No Battery Connection
		Fast Flash	Battery Over-Discharged
	Load Status	Flash	DC Load Short Circuit or Over-Load
		On	Load On
		Off	Load Off

### Key Functionality Chart

Function Key	System Mode	Input	Input Function
	View Mode	Short Press	Enter SET mode
	View Mode	Short Press	View Previous Page
	View Mode	Short Press	View Next Page
	View Mode	Short Press	DC Load On/Off (Manual Control Program Only)

Function Key	System Mode	Input	Input Function
	Mode	Long Press	Save Data & Exit SET Mode
		Short Press	Next Setting
	Set Mode	Short Press	Increase Parameter Value
	Set Mode	Short Press	Decrease Parameter Value
	Set Mode	Short Press	Exit SET Mode Without Saving

## LCD Display & Cycles

Pre start-up display while the MPPT controller turns on, this usually lasts several seconds while the controller detects the operating environment.

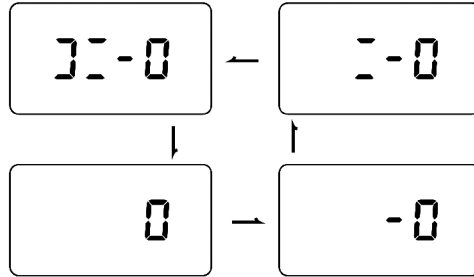

## LED Screen Display Cycle

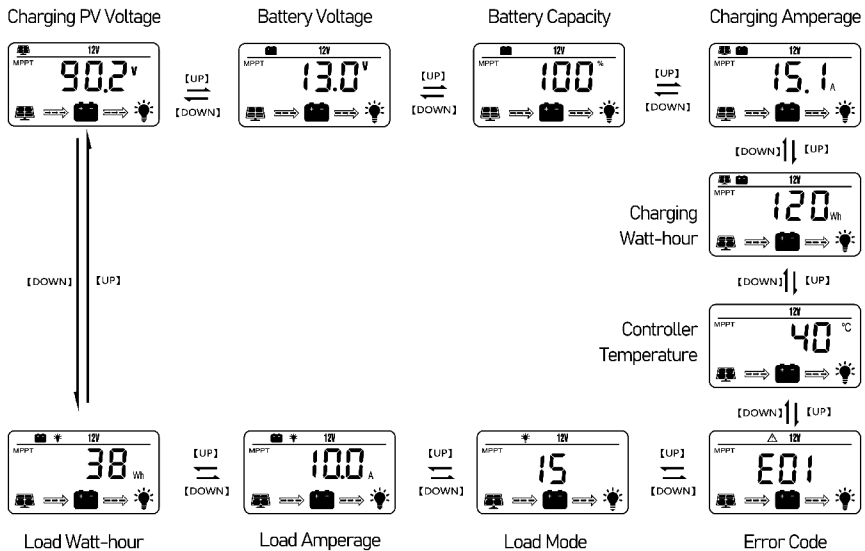

- The battery voltage view will be displayed by default. Use the up and down arrow keys to cycle through different views. The battery voltage view will resume upon 30 seconds of inactivity. The error code view will be displayed when an error is detected. The backlight in the screen will be on for 20 seconds with any button operation.

## Setting Battery Mode

Enter SET mode by pressing the Setting key in any view page other than Load Mode. Use the up and down arrow keys to select battery mode, then long press the Setting key to save.

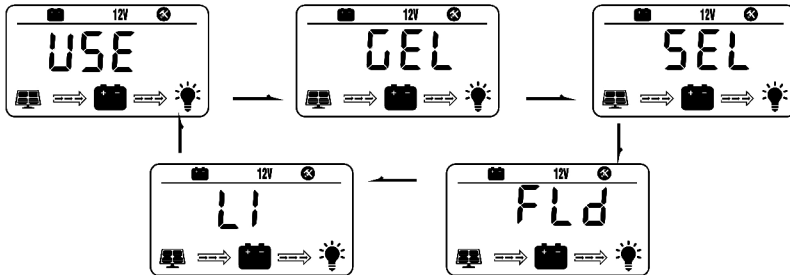

Abbreviations	Battery Types	Description
FLD	Flooded Battery	Auto-recognition with default parameters set for each type of batteries.
	Sealed/AGM Battery	
	Gel Battery	
LI	Lithium Battery	Some parameters can be customized.
Use	Advanced User Mode	Most parameters can be customized.

## Advanced Battery Settings

In Lithium or User mode, short press the Setting key again to cycle through each parameter view.

Use the up and down arrow key to adjust parameter values, then long press Setting key to save.

For Battery Type: Li

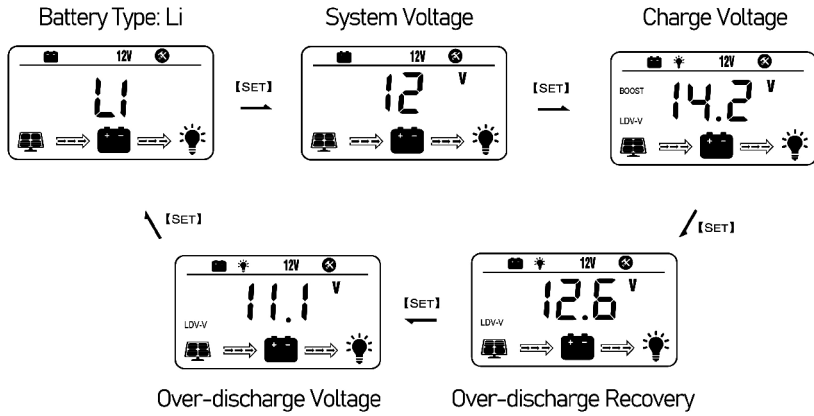

For Battery Type: USER

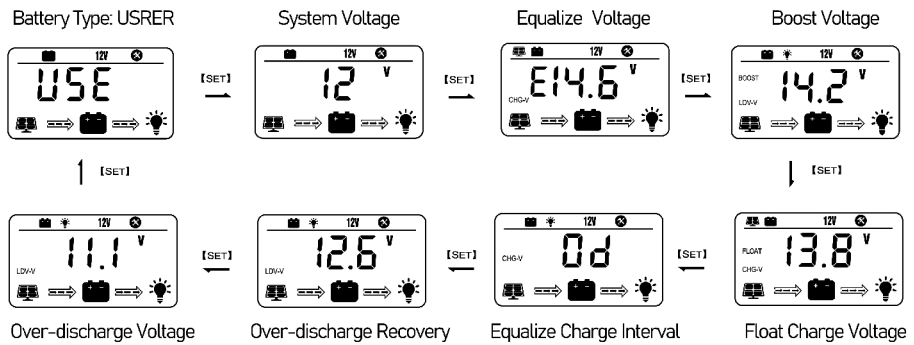

## Load Mode Settings

Enter Load SET Mode by pressing the Setting key in Load Mode view only. Use the arrow key to cycle through load modes before long pressing SET to save and exit. Short pressing SET will exit without saving.

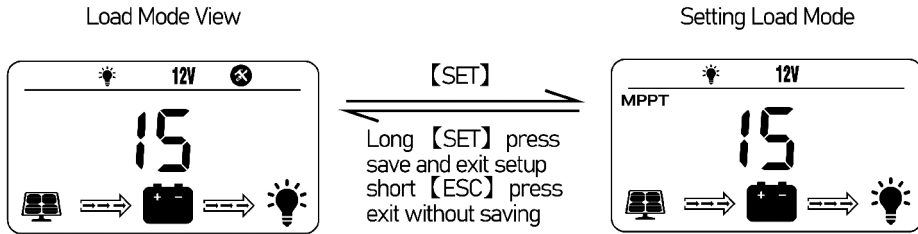

Mode	Definition	Description
0	Daylight Auto-Control	DC load turns on when no daylight is detected
1~14	Daylight On/Timer Off	DC load turns on when no daylight is detected
15	Manual Mode	DC load turns on/off by pressing the Return key
16	Testing Mode	DC load turns on and off in a quick succession
17	Always On	DC load stays on



## Error Code Chart

Code	Error	Description & Quick Troubleshoot
E00	No Error	No action needed
E01	Battery Over-discharged	Battery voltage is too low. DC load will be turned off until battery re-charges to recovery voltage
E02	Battery	Battery voltage has exceeded controller limit. Check battery bank voltage for compatibility with controller
E04	Over-voltage	DC load short circuit
E05	Load Short Circuit	DC load power draw exceeds controller capability. Reduce load size or upgrade to a higher load capacity controller
E06	Load Overload	Controller exceeds operating temperature limit. Ensure the controller is placed in a well-ventilated cool, dry place.
E08	Overheating	Solar array amperage exceeds controller rated input amperage. Decrease the amperage of solar panels connected to the controller or upgrade to a higher rated controller
E10	Solar Over-amperage	Solar array voltage exceeds controller rated input voltage. Decrease the voltage of solar panels connected to the controller
E13	Solar Over-voltage	Solar array input wires connected with reverse polarity. Disconnect and re-connect with correct wire polarity
E14	Solar	Battery connection wires connected with reverse polarity. Disconnect and re-connect with correct wire polarity

\*Please contact Ampron for technical support on additional troubleshooting.

## Controller Specification

The variable “n” is adopted as a multiplying factor when calculating parameter voltages, with the rule for “n” being: if battery system voltage is 12V, n=1; 24V, n=2; 36V, n=3; 48V, n=4.

For example, the equalize charge voltage for a 12V FLD (Flooded) battery bank is  $14.8V * 1 = 14.8V$ . The equalizing charge voltage for a 24V FLD (Flooded) battery bank is  $14.8V * 2 = 29.6V$ .

Parameter	Value			
Model No.	AM2420N	AM2430N	AM2440N	AM4860N
System Wiring Grounded	Negative Grounded			
Battery System Voltage	12V/24V Auto (FLD/GEL/SLD) Manual (Li/User)		12V/24V/36V/48V Auto (FLD/GEL/SLD) Manual (Li/User)	
No-load Loss	12ma (12V), 10ma (24V)		12ma (12V), 10ma (24V), 8ma (36V), 6ma (48V)	
Max Solar Input Voltage	<100Voc		<150Voc	
Rated Solar Charge Current	20A	30A	40A	60A
Max Solar Input Power	300W/12V 600W/24V	450W/12V 900W/24V	600W/12V 1200W/24V	900W/12V 1800W/24V 2600W/36V 3200W/48V
Light Control Voltage	5V*n			
Light Control Delay Time	10s			
Max Load Output Current	20A			
Operating Temperature	-35°C ~ +45°C			
IP Protection	IP32			
Net Weight	1.0 kg	2.0 kg	2.0 kg	3.0 kg
Communication Port	RS485			
Operating Altitude	≤ 3000 meters			
Controller Dimension	180*140*71 mm	245*180*82.5 mm	280*210*90 mm	

Parameter	Battery Parameters				
	FLD	SEL	GEL(default)	USER (adjustable)	LI (adjustable)
Battery Types	FLD	SEL	GEL(default)	USER (adjustable)	LI (adjustable)
Equalize Charge Voltage	14.8V*n	14.6V*n	--	Default	--
Boost Charge Voltage	14.6V*n	14.4V*n	14.2V*n	Default: GEL	Default: 14.2V*n
Float Charge Voltage	13.8V*n			Default: GEL	--
Boost Charge Recovery Voltage	13.2V*n			Default: GEL	--
Over-discharge Recovery Voltage	12.6V*n			Default: GEL	--
Over-discharge Voltage	11.1V*n			Default: GEL	Default: 11.1V*n
AutoTemperature Compensation	-3mV/2V/°C			Default: GEL	--

## Product Dimensions

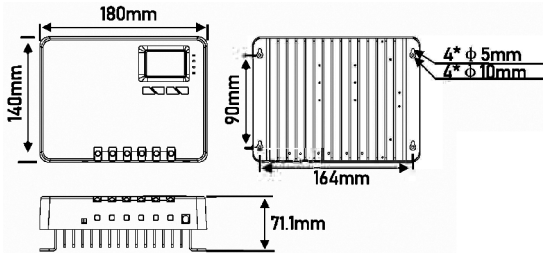

### AM2420N Model

Product Dimensions:

180\*140\*71.1mm

Installation Area Dimensions:

164\*90mm

Installation Hole Size:

φ5mm&φ10mm

Connection Socket Size:

7.5\*7.5mm

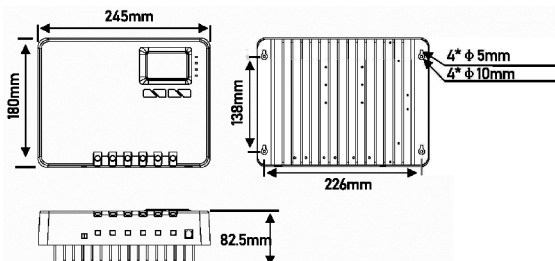

### AM2430N & M2440N Model

Product Dimensions:

245\*180\*82.5mm

Installation Area Dimensions:

226\*138mm

Installation Hole Size:

φ5mm&φ10mm

Connection Socket Size:

7.5\*7.5mm

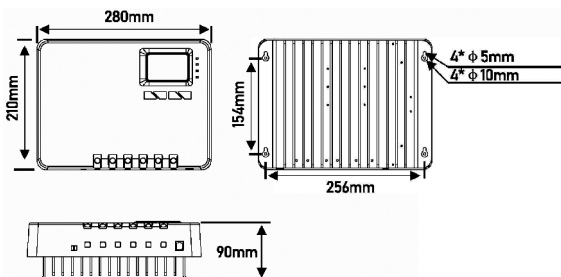

### AM4860N Model

Product Dimensions:

280\*210\*90mm

Installation Area Dimensions:

256\*154mm

Installation Hole Size:

φ5mm&φ10mm

Connection Socket Size:

7.5\*7.5mm